

# 900 LT-SERVICE S3 TOOLBOX

THE 900 LT SERVICE TOOLBOX IS BASED ON THE POPULAR LT-SERVICE SHAPE. THE BOX HAS A GAS STRUT ASSISTED DOOR WITH STAINLESS STEEL LOCKS. IT FEATURES ADJUSTABLE SHELVING, WITH ONE SHELF SUPPLIED AS STANDARD. THE UNIT COMES POWDERCOATED IN A RANGE OF COLOURS. IT IS MOUNTED ON RAILS AND CAN BE BOLTED TO YOUR ALUMINIUM OR STEEL TRAY. COMBINE SEVERAL BOXES DEPENDING ON YOUR TRAY SIZE AND INDIVIDUAL REQUIREMENTS.

- SUITABLE FOR ALL 1 TONNE VEHICLES.

- LIGHT WEIGHT, RUST RESISTANT ALUMINIUM CONSTRUCTION.

## OPTIONS:

ADDITIONAL SHELVING

SLIDE OUT DRAWERS

SLIDE OUT WORKBENCH

ADJUSTABLE GAS BOTTLE MOUNTS

VENTED COMPARTMENTS

ROTARY VENTS

RUBBER OR CARPET FLOOR/SHELF MATS

BI-FOLD DOORS

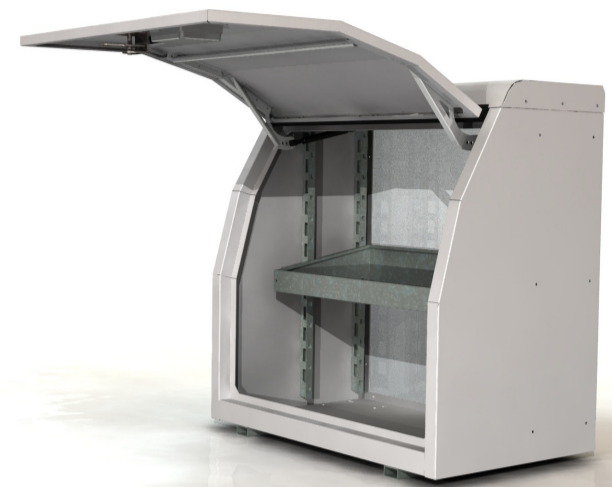

\*REFER TO WEBSITE FOR FULL LIST OF ACCESSORIES & PRICES

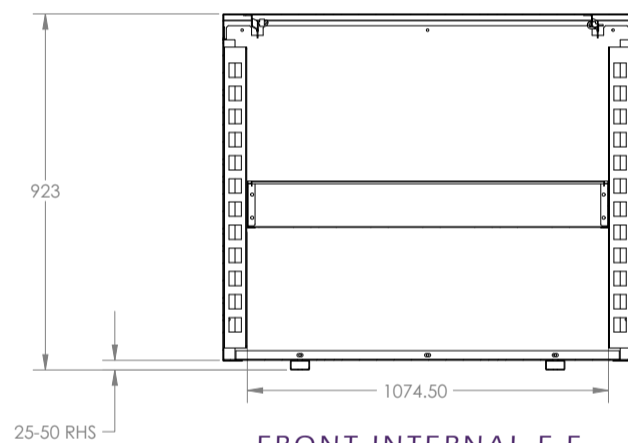

FRONT INTERNAL F-F SECTION VIEW

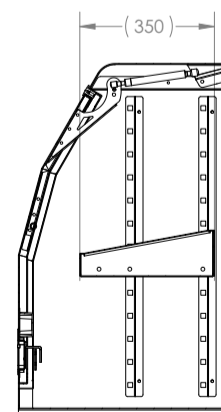
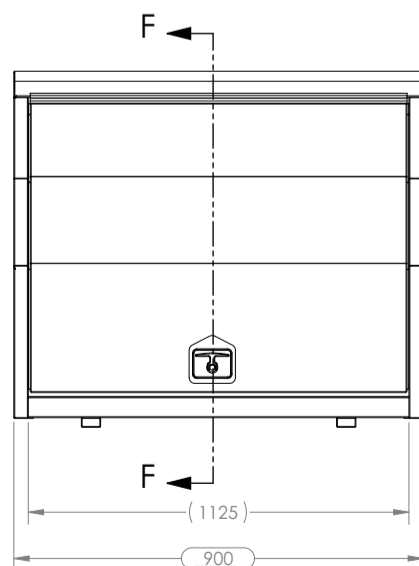
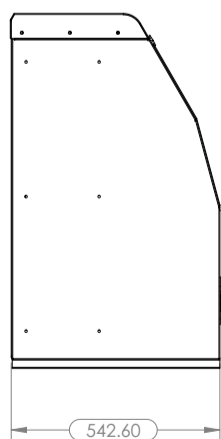
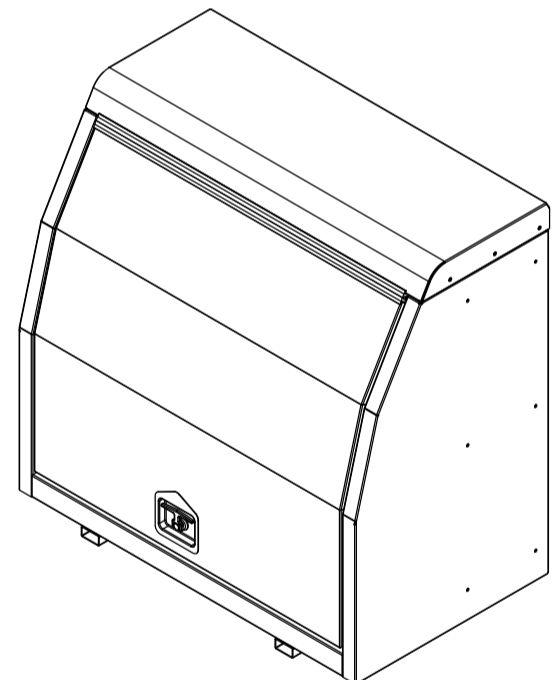
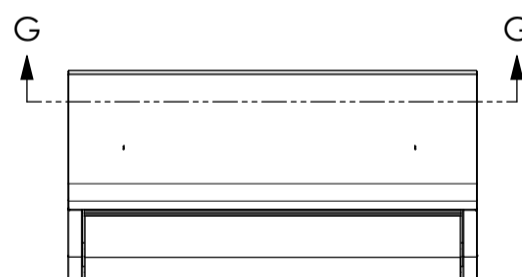

SIDE INTERNAL F-F SECTION VIEW

# TTSB

## TRADE SERVICE BODY

28 Quality Drive, Dandenong, Victoria, 3175  
 ph 1300 131 574 Email info@tsb.net.au  
[www.tsb.net.au](http://www.tsb.net.au)